

LED照明用导光光纤 | S1/S2

LED照明, RGB混色组件用导光光纤。



通用技术指标

外皮	SUS管
光纤径 (μm)	50
保护管径 (φ) (mm)	6
开口角 (NA)	0.56
SUS软管外径 (φ) (mm)	10±0.2

信息

- ▶如希望SUS软管+PVC, 或SUS半刚性管的话, 请咨询。
- ▶和LED照明连接时, 需要用到导光光纤用适配器。

技术指标

型号	类型	出射端形状 (mm)	L寸法 (mm)	
S1S8-500F	单管	φ8	500	
S1S8-1000F			1,000	
S1S8-1500F			1,500	
S2S8-500I-V	双管	φ8	500	
S1L30-500F-R	线形照明	30×0.95	500	
S1L30-1000F-R			1,000	
S1L30-1500F-R			1,500	
S1L50-500F-R		50×0.57	500	
S1L50-1000F-R			1,000	
S1L50-1500F-R			1,500	
S1L100-1000F-R	100×0.29	1,000		
S1L100-1500F-R		1,500		
S1R18-500F-R	环形照明	R18	500	
S1R18-1000F-R			1,000	
S1R18-1500F-R			1,500	
S1R25-500F-R		R25	500	
S1R25-1000F-R			1,000	
S1R25-1500F-R			1,500	
S1R32-500F-R	R32	500		
S1R32-1000F-R		1,000		
S1R32-1500F-R		1,500		
S1P30-1000F-R	面发光	□30	1,000	
S1P30-1500F-R			1,500	
S1P60-1000F-R			□60	1,000
S1P60-1500F-R				1,500

导光光纤用适配器 | AD-0808

RoHS

外形图

(单位: mm)

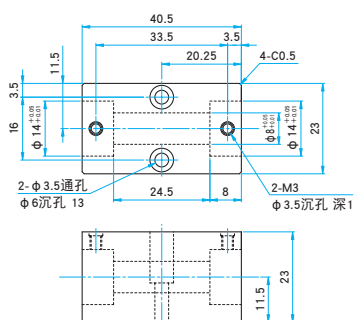

技术指标

型号	外形尺寸 (mm)	材料
AD-0808	(W) 40.5×(H) 23×(D) 23	铝合金



外形图

(单位: mm)

S1S8-500F/S1S8-1000F/S1S8-1500F

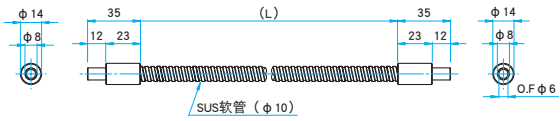

S1L30-500F-R/S1L30-1000F-R/S1L30-1500F-R

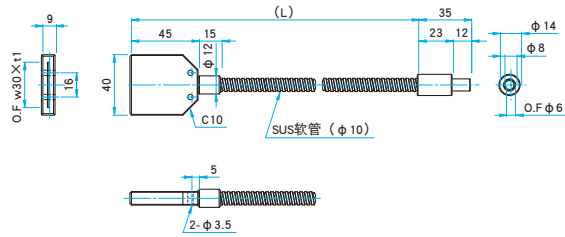

S1L50-500F/S1L50-1000F/S1L50-1500F

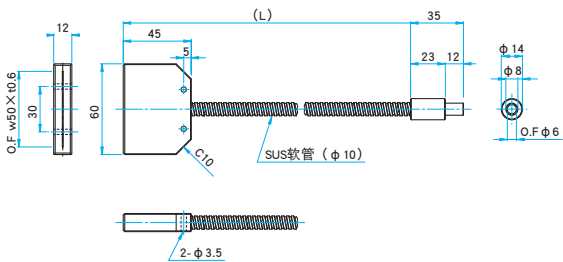

S1L100-1000F-R/S1L100-1500F-R

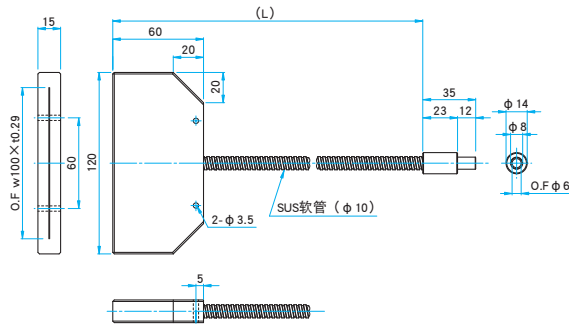

S1R18-500F/S1R18-1000F/S1R18-1500F

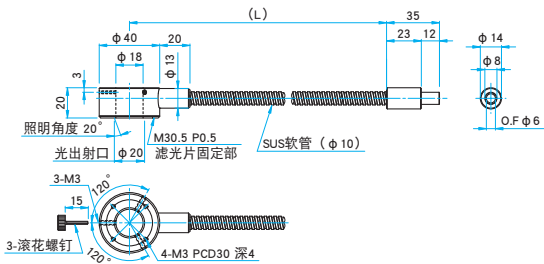

S1R25-500F-R/S1R25-1000F-R/S1R25-1500F-R

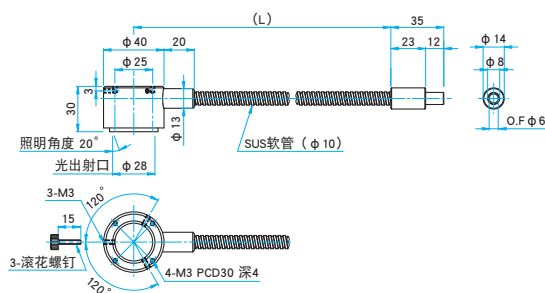

S1R32-500F/S1R32-1000F/S1R32-1500F

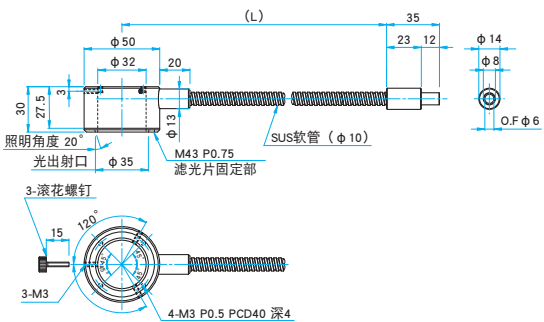

S1P30-1000F-R/S1P30-1500F-R

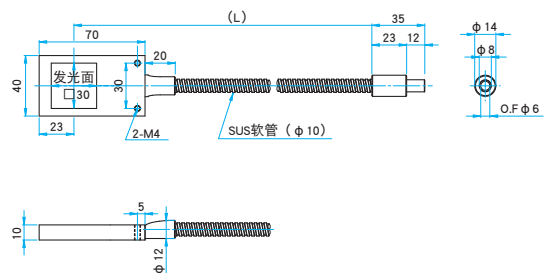

S1P60-1000F/S1P60-1500F

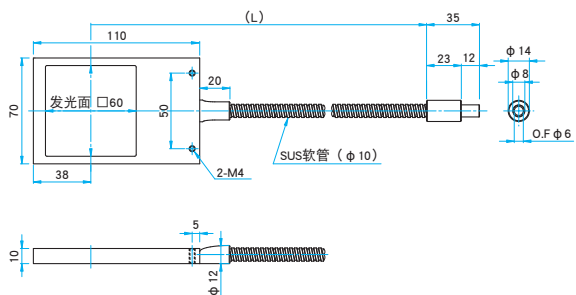

S2S8-500I-V

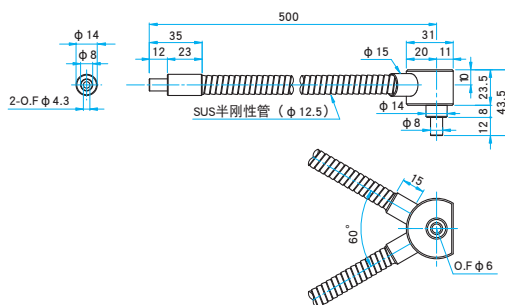

应用系统

光学元件·
薄膜产品

镜架

底座

手动平台

驱动装置

自动平台

光源

目录

介绍

激光器

光检测

激光保护用具

光源