

M6/INCH

M6/INCH type parts can mount to M6 or 1/4-20 holes on standard hole spacing.



- M16P1 tapped holes fit a post holder or post. Other tapped holes on the top surface allow for different sized stages to be secured.
- 7 mm slotted bases can be use on both metric and inch hole patterns.
- The base clamp (BSC-60) allows a base plate to be secured at an arbitrary position where there is no tapped hole.



Outline Drawing

BSP-2460

- Hexagonal socket headcap screw M6x18...2 screws
- Flat washer

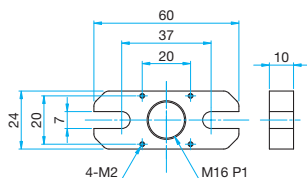

BSP-40100

- Hexagonal socket headcap screw M6x14...2 screws
- Flat washer

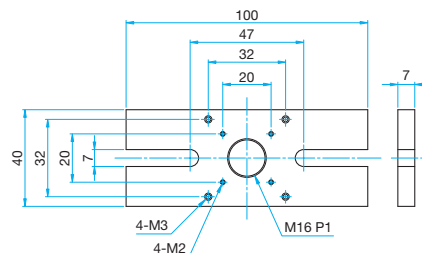

BSP-70120

- Hexagonal socket headcap screw M6x14...6 screws
- Flat washer

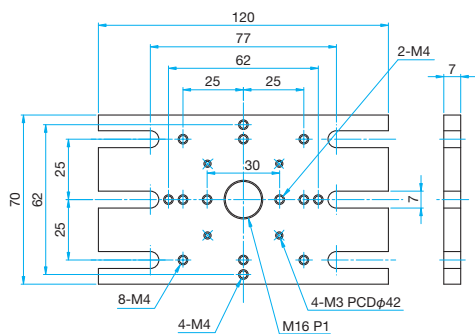

BSP-70170

- Hexagonal socket headcap screw M6x14...6 screws
- Flat washer

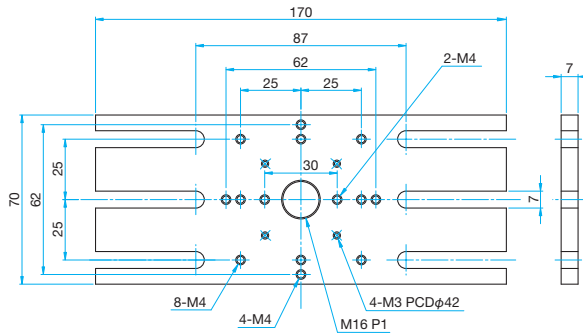

BSPS-246010

- Hexagon socket head cap screw (stainless steel construction) M6x18...2 screws, Flat washer

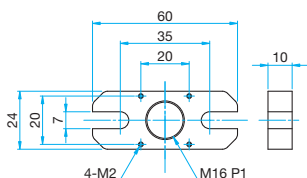

BSPS-4010010

- Hexagon socket head cap screw (stainless steel construction) M6x18...2 screws, Flat washer

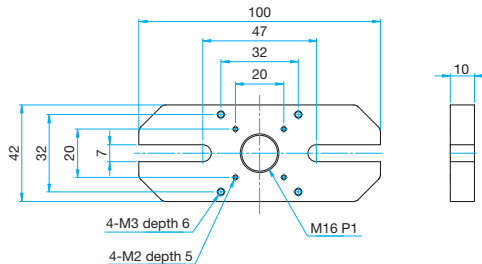

M6	Primary material: Aluminum Finish: Black Anodized
Part Number	Weight [kg]
BSP-2460	0.027
BSP-40100	0.06
BSP-70120	0.13
BSP-70170	0.18

M6	Primary material: Stainless Steel Finish: None
Part Number	Weight [kg]
BSPS-246010	0.078
BSPS-4010010	0.26



Application Systems

Optics & Optical Coatings

Opto-Mechanics

Bases

Manual Stages

Actuators & Adjusters

MotORIZED Stages

Light Sources & Laser Safety

Index

Guide

Vibration Isolation Systems

Optical Tables

Darkrooms/ Dark Boxes

Optical Bases

Posts

Brackets

Adapters

Tools



M6/INCH		Primary material: Aluminum Finish: Black Anodized
Part Number	Weight [kg]	
FBP-50UU	0.03	
FBP-65UU	0.03	
BSP-65EE	0.03	
FBP-75WUU	0.05	
BSP-85EE	0.06	
BSP-85UU	0.06	
BSP-120EE	0.13	
BSP-120UU	0.13	



Outline Drawing

FBP-50UU/65UU

- Hexagonal socket headcap screw M6x8, M6x18...1 pieces each (EC)
- Hexagonal socket headcap screw 1/4-20UNCx5/16, 1/4-20UNCx3/4...1 pieces each (US)
- Hexagon socket head cap screw (stainless steel construction) 1/4-20UNCx5/16...1 pieces each (US)

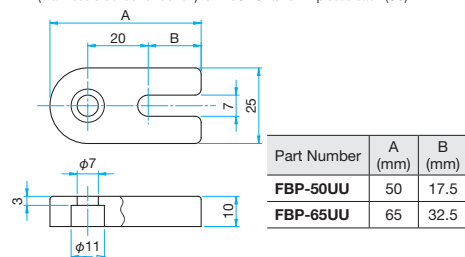

BSP-65EE

- Hexagonal socket headcap screw M6x15...2 screws (EC)
- Hexagonal socket headcap screw 1/4-20UNCx5/8...2 screws (US)

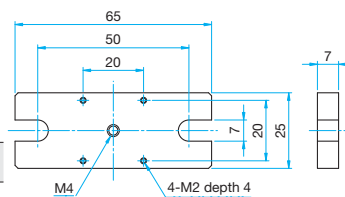

FBP-75WUU

- Hexagonal socket headcap screw M6x8, M6x18...1 pieces each (EC)
- Hexagonal socket headcap screw 1/4-20UNCx5/16, 1/4-20UNCx3/4...1 pieces each (US)
- Hexagon socket head cap screw (stainless steel construction) 1/4-20UNCx5/16...1 pieces each (US)

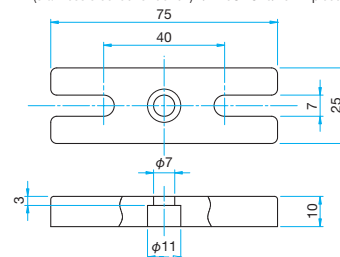

BSP-85EE/85UU

- Hexagonal socket headcap screw M6x15...2 screws (85EE)
- Hexagonal socket headcap screw 1/4-20UNCx5/8...2 screws (85UU)

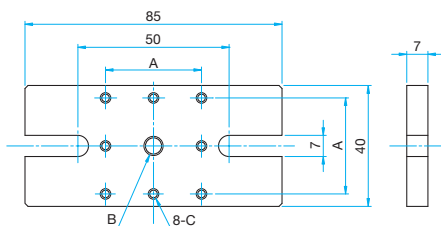

Part Number	A (mm)	B	C
BSP-85EE	32	M6 P1	M3
BSP-85UU	31.75	1/4-20UNC	6-32UNC

BSP-120EE/120UU

- Hexagonal socket headcap screw M6x15...2 screws (120EE)
- Hexagonal socket headcap screw 1/4-20UNCx5/8...2 screws (120UU)

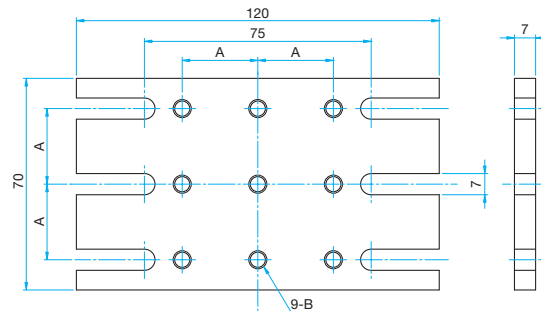

Part Number	A (mm)	B
BSP-120EE	25	M6 P1
BSP-120UU	25.4	1/4-20UNC

M2

Designed to mount optical units on optical baseplates (OBB) with M2 tapped holes.

Guide

Optical baseplates (OBB) with M2 tapped holes are also available.

Specifications		Primary material: Aluminum Finish: Black Anodized
Part Number	Weight [kg]	
BSP-24	0.004	
BSP-39	0.006	
BSP-50	0.016	

Outline Drawing

- BSP-24** Pan head screw M2x8...2 screws
Flat washer

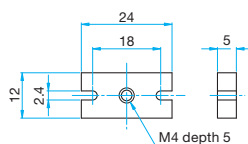

- BSP-39** Pan head screw M2x6...1 screw

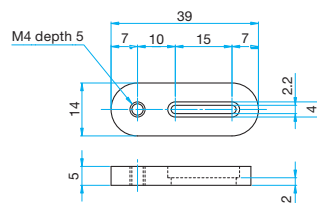

- BSP-50** Pan head screw M2x6...6 screws

